



MANHATTAN BED



ASSEMBLY INSTRUCTIONS

Thank you for choosing our new adjustable height bed frame.

This practical design offers the utmost in versatility.

Before assembling your Manhattan Bed, please read through these instructions carefully, familiarising yourself with the different parts.

Please note that you will require a Phillips Head Screw-driver and an Allen Key.



Assembling by Adult

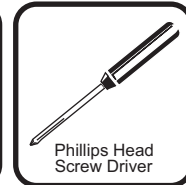

Phillips Head
Screw Driver

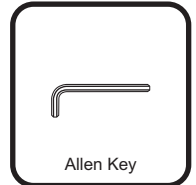

Allen Key



Instructions apply for all sizes of bed
> Twin > Full > Queen > King

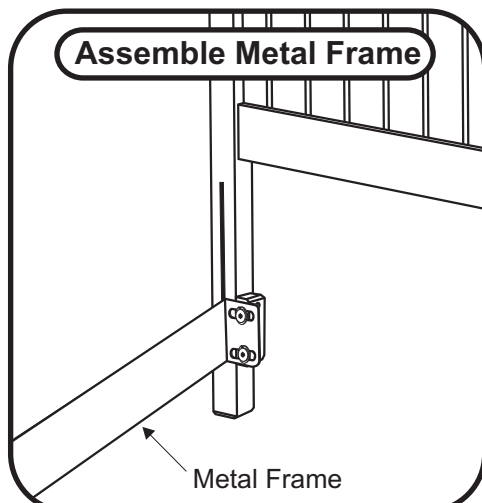

HARDWARE

For Headboard, Footboard to Metal Bed Frame



5/8" Allen Bolts - 8 pcs.
For Headboard, Footboard to metal Bed Frame



Split Washer - 8 pcs



Flat Washer - 8 pcs

PARTS LIST

- 01 **HARDWARE** — BOX 1 OF 4
- 02 **HEADBOARD** — BOX 2 OF 4
- 03 **FOOTBOARD** — BOX 2 OF 4
- 04 **SIDE RAIL** — BOX 3 OF 4
- 05 **SLAT KIT** — BOX 4 OF 4

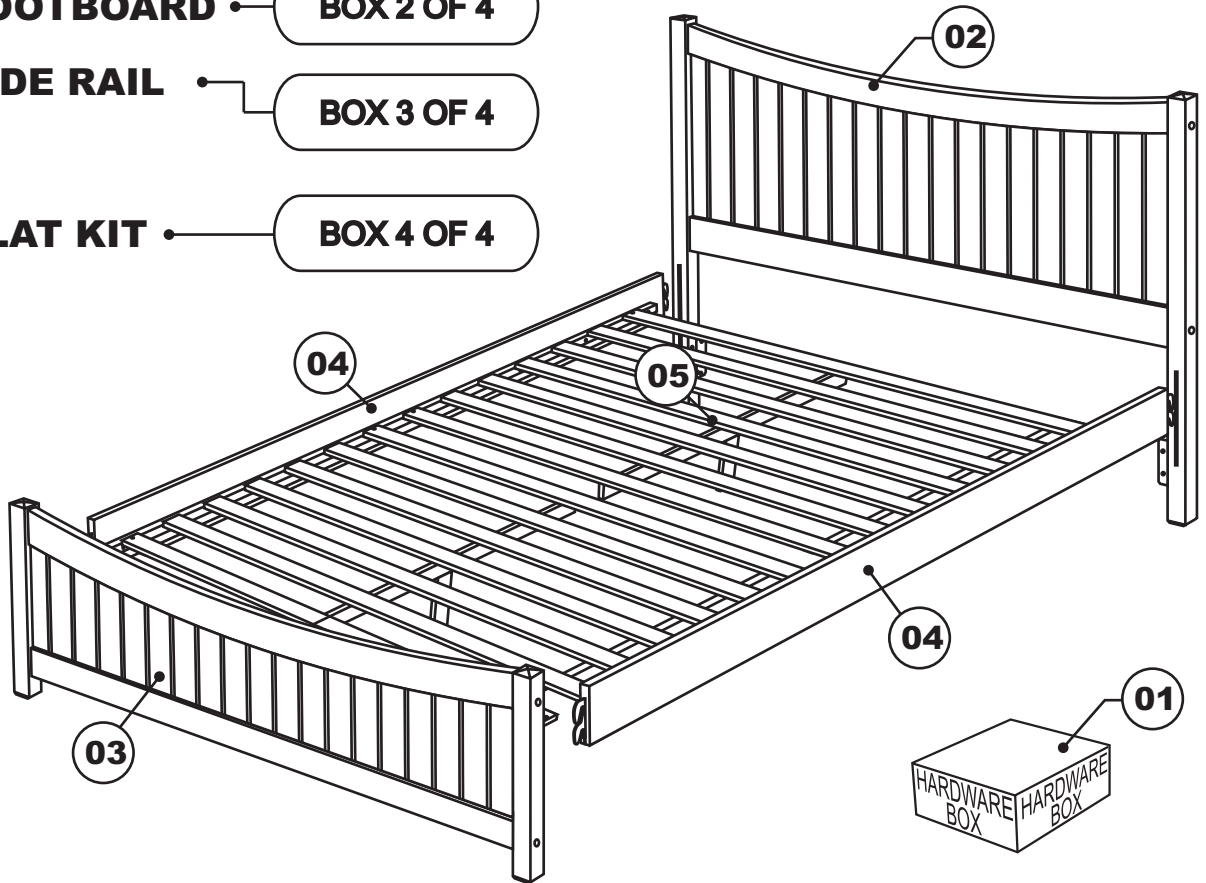

STEP 1

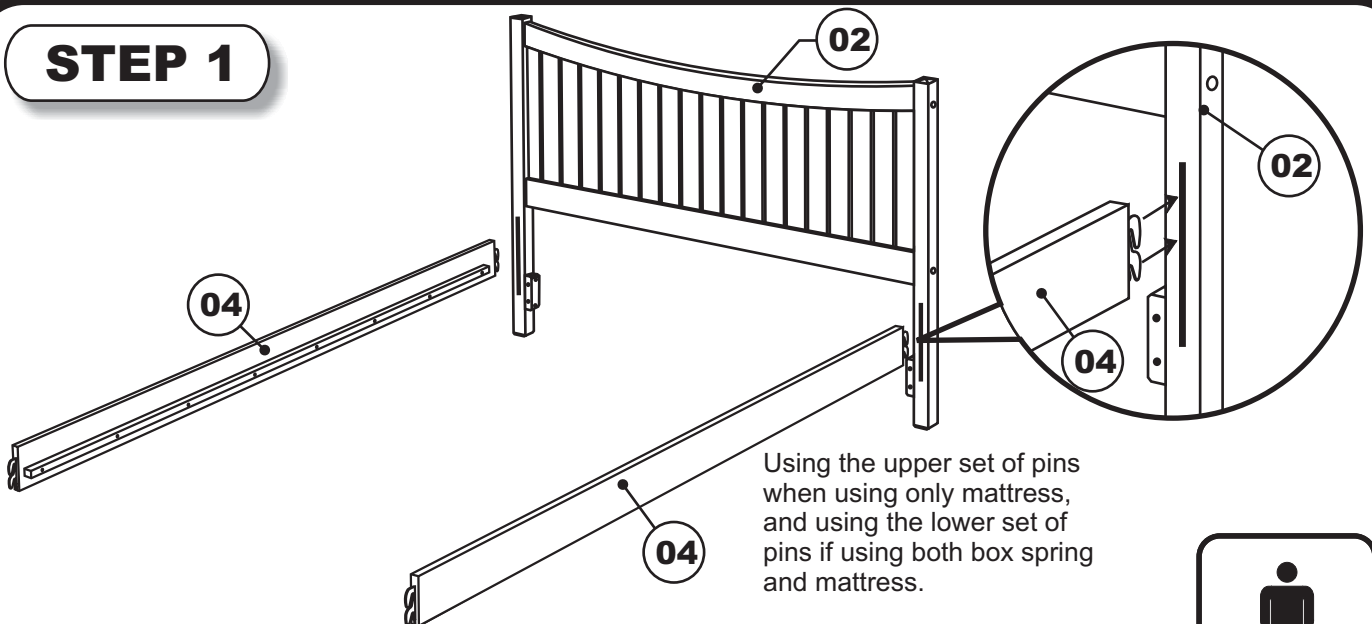

Attach the Side Rail to Headboard using bed hook as shown. Repeat with the other Side Rail.



STEP 2

Using the upper set of pins when using only mattress, and using the lower set of pins if using both box spring and mattress.

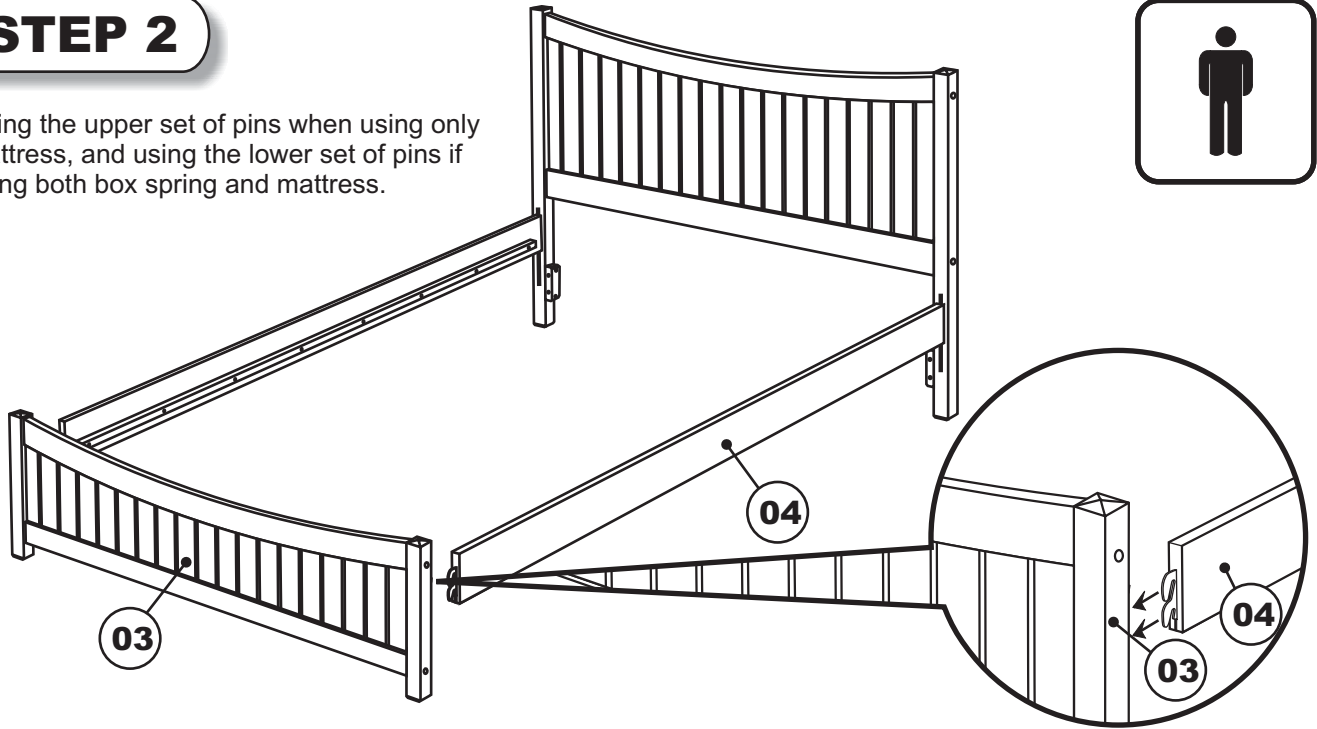

Attach the other end of the Side Rails to the Footboard using bed hook as shown.

STEP 3

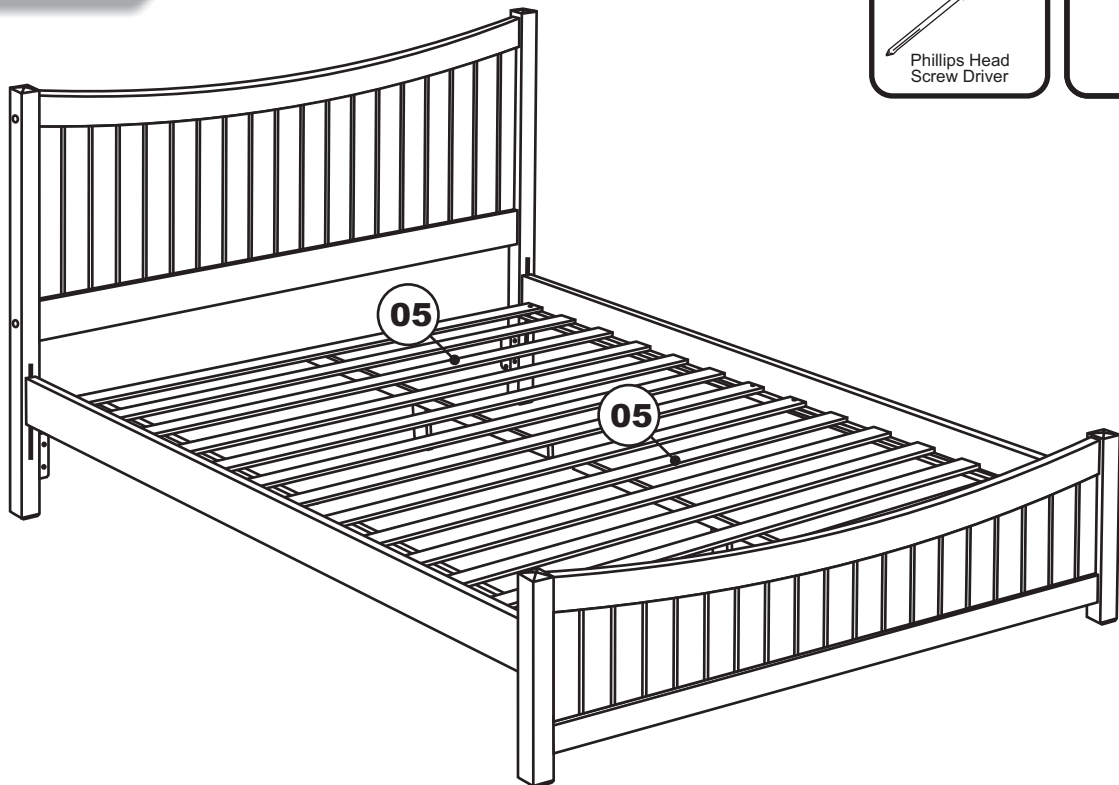

For Slat Kit Assembly, follow Assembly Instruction included with Slat Kit.

Congratulations !

Your Manhattan Bed is now ready for use.

We recommend that you recheck that all screws are tightened
And that all parts are secure before use and Periodically to ensure Safety.